

*New*

# LCC-300 software

## User manual



### **Configuration software**

*for Class 200/300 and displays*

**units - ranges - relays - set points - alarms**  
**analogue outputs - channels - regulations**



# Summary

<b>I - Minimum System Requirements</b>	
I 1 - Minimum recommended configuration	p 2
I 2 - Installing the software	p 2
I 3 - Uninstalling the software	p 2
I 4 - Launching the software	p 2
<b>II - Connecting the transmitter</b>	p 2
<b>III - Configuration of the transmitter</b>	
III 1 - Principle	p 3
III 2 - Configuration of the display and keypad	p 4
III 2a - Channel of the transmitter for the infrared remote control	p 4
III 2b - RS 232 communication	p 4
III 2c - Slave address	p 4
III 2d - Locking the keyboard	p 4
III 2e - Backlight	p 4
III 2f - Display contrast setting	p 5
III 3 - Configuration of the channels and units of measurement	p 5
III 3a - Input Configuration	p 5
III 3b - Units and channels	p 5
III 3c - Management of configurable units	p 7
III 4 - Management of analogue outputs	p 7
III 4a - Setting the analogue outputs	p 7
III 4b - Activating / deactivating the analogue inputs	p 7
III 4c - Conversion chart	p 8
III 5 - Setting of alarms / relays	p 8
III 5a - Activating / deactivating the buzzer	p 8
III 5b - Security level of alarms	p 8
III 5c - Tags for alarms / relays and LED color control	p 9
Visual and audible alarms	p 9
Relays	p 9
III 5d - Selecting the channel for visual alarms and relays	p 9
III 5e - Explanations of available alarms mode	p 10-11
Description	p 10
Available configurations	p 10-11
III 5f - Alarm selection	p 11
III 5g - Setting the set points and time-delay	p 11
Set points	p 11
Delay	p 11

<b>III 6 - Configuration of pressure measurement</b> .....	p 12
III 6a - Pressure Integration coefficient.....	p 12
III 6b - Time-delay between 2 self-calibration.....	p 12
<b>III 7 - Configuration of humidity measurement</b> .....	p 12
III 7a - Setting the offset in humidity and temperature.....	p 12
III 7b - Offset reset.....	p 12
<b>III 8 - Configuration of air velocity measurement</b> .....	p 13
III 8a - Type of temperature compensation.....	p 13
<i>Automatic compensation</i> .....	p 13
<i>Manual compensation</i> .....	p 13
III 8b - Selecting the air velocity coefficient.....	p 14
<i>Automatic input of coefficient</i> .....	p 14
<i>Manual input of the coefficient</i> .....	p 14
III 8c - Input of air velocity correction coefficient.....	p 14
<i>How to calculate the coefficient</i> .....	p 14
<i>Input of the coefficient</i> .....	p 14
III 8d - Selecting the type of duct and the flow coefficient.....	p 14
<i>Rectangular duct</i> .....	p 14
<i>Circular duct</i> .....	p 15
<i>Flow coefficient</i> .....	p 15
<b>III 9 - Purge mode</b> .....	p 16
III 9a - Activation / deactivation of purge mode.....	p 16
III 9b - Working duration of purge mode.....	p 16
III 9c - Frequency.....	p 16
III 9d - Time-delay.....	p 16
<b>III 10 - Error code</b> .....	p 17

<b>IV - Transferring a configuration to the transmitter</b> .....	p 17
---	------

## **V - Saving a configuration**

<b>V 1 - Principle</b> .....	p 18
<b>V 2 - Saving a configuration</b> .....	p 18

## **VI - Opening a configuration**

<b>VI 1 - Principle</b> .....	p 19
<b>VI 2 - Opening a configuration</b> .....	p 19
<b>VI 3 - Transferring a configuration</b> .....	p 20
<b>VI 4 - Deleting a configuration</b> .....	p 20

## **VII - Main menu**

"Commands" menu.....	p 20
"Parameters" menu.....	p 20
"Help" menu.....	p 20



## I - Minimum system requirements

### I1- Minimum recommended configuration :

- Pentium II 300 MHz - 32 Mo RAM
- CD-Rom drive
- Windows 98-NT4-XP
- 20 Mb free on hard disk
- Minimum resolution 800 x 600 (1024 x 768 recommended)
- Serial communication port (RS 232)
- Internet Explorer 6.0 or better

### I2- Installing the software :

**Insert the CD into the CD-Rom driver. The KIMO welcome window appears automatically.**

If the installation does not automatically begin, click Start and click Run. In the Run dialog box, enter "d:\detup" (d is the letter of your CD-Rom driver), then click OK.

### I3- Uninstalling the software:

To uninstall the "LCC300", it is required to have the rights (under NT) and to use the Windows tool :

- Go to the menu "Run", "Parameters", "Control Panel", then "Install/Uninstall programmes".
- In the field "Installation/Uninstallation", click on "KIMO LCC 300" and follow the instructions.

### I4- Launching the software :

To run the LCC application :

- Click on the icon  from your desktop.
- OR
- Click on Start / Programms and "LCC 300".

## II - Connecting the transmitter



- **First power the transmitter (before connecting it to the computer).**
- **When the configuration is done, disconnect the transmitter from the PC, and then switch it off.**

To access or to modify the configuration, please follow the instructions as shown below :

- **Step 1** : power the transmitter up (see technical datasheet).
- **Step 2** : wait a few seconds while the transmitter initializes.
- **Step 3** : connect the transmitter to the PC via the RS 232 cable.

You can connect the transmitter to the PC before or after the launching of the software.

- If you connect the transmitter to the PC **before** the launching of the software, the message shown beside appears. Then, click on "Yes" to access to the configuration parameters (cf. P3-15).
- If you connect the transmitter to the PC **after** the launching of the software, you directly access to the 2 main menus of the LCC-300 :
  - Read configuration
  - Open configuration from database

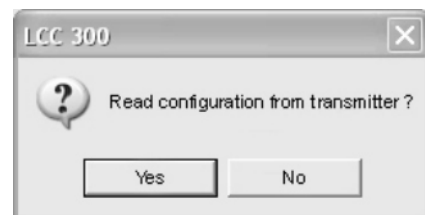
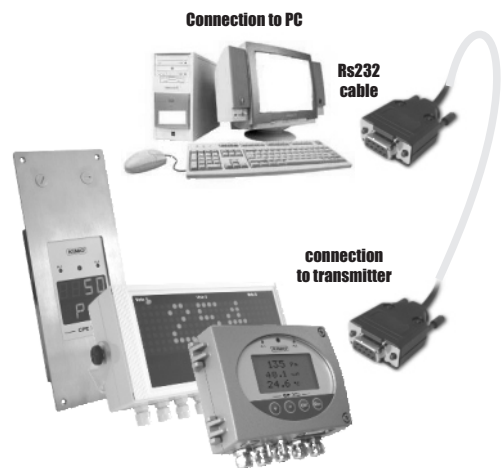



## III - Configuration of the transmitter

### III 1- Principle :

When opening the LCC-300 software, two buttons appear on the screen :

- **Read configuration**
- **Open configuration from database**

#### Function : READ A CONFIGURATION



Using the function "Read configuration", you may access to the configuration of the transmitter. You can then read or modify the configuration of the transmitter. A new configuration can be transferred to the transmitter and/or saved in a database (for a later use).

To access the configuration parameters, you can either :

- click on "Read configuration"

Or

- go in the menu "Commands" and then click on "Read configuration" (see. page 18).

**Click on "next".**



If the message shown beside is displayed, it means that there is a connexion problem between the transmitter and the PC. Then you may :

- Check that the transmitter is correctly powered
- Check the connection of the RS 232 cable.
- Check the communication port and, if required, select another port (see page 18).

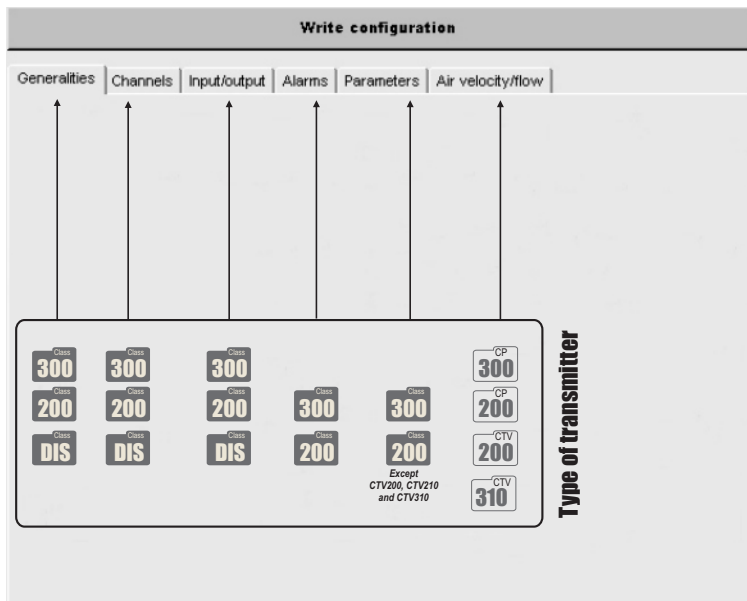
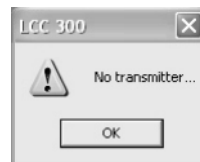

#### The window shown beside appears .

This window has a function button and 3 to 6 tabs (depending on the transmitter connected) :

- Class 300** ..... Class 300 (CP, CPE, TH and CTV).
- Class 200** ..... Class 200 (CP, TH and CTV).
- Class DIS** ..... Displays (ATT and ATE).
- CP 300** ..... CP 300 Transmitters

• Via the function button, you can transfer the configuration to the transmitter.

• The tabs "Generalities", "Channels", "Input/Output", "Alarms", "Parameters" and "Air velocity/flow" show all relative information regarding the configuration of the transmitter. Click on the tab required to display the information.



## III 2 - Configuration of the display and the keypad :

The tab "Generalities" gives you access to different information relative to the communication of the transmitter, to its display and keypad :

- Transmitter channel for the infrared remote control .
- RS 232 communication.
- Slave address (Modbus).
- Keyboard locking.
- Back light.
- Display contrast setting.

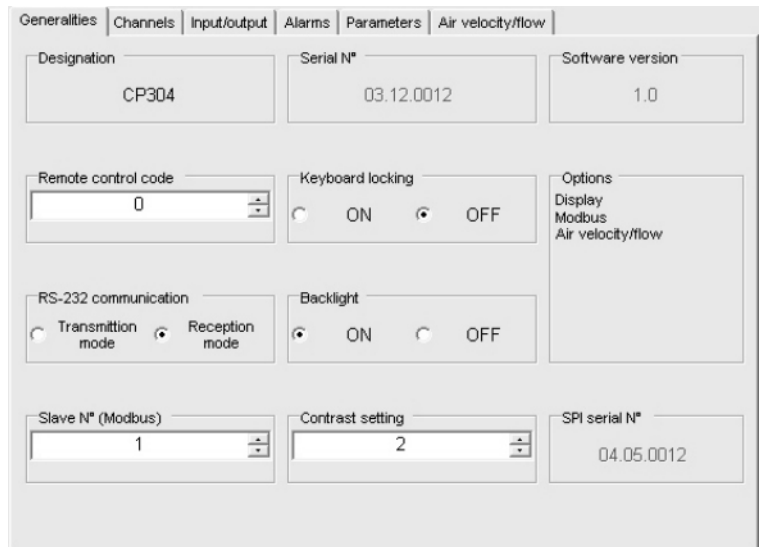

### III2a - Channel of the transmitter for the infrared remote control :

Class 300, 200, DIS



You can change the transmitter channel number for the reception of the infrared remote control signal. **The advantage is that you can pilot several transmitters with only one remote control**, especially when the transmitters are side by side.

The default channel number of the transmitter is 0.

To change the channel number of the transmitter, use the arrows on the right side of the zone "Remote control code", or directly enter the value.

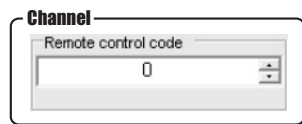

### III2b - RS 232 Communication :

Class 300, 200

Transmitters from class 300 have a RS232 output and a RS485 digital output (Modbus network system - optional). Via the RS232, you can receive the data (2 measurement channels maximum) measured by a transmitter from class 200/300 or send the data to another transmitter from Class 300.

**! If you wish the transmitter to send its data to another transmitter via the RS232, then you will not be able to use the RS485 digital output (Modbus - optional)**

To send data via the RS232, select "Transmission mode" in the field "RS 232 Communication". To receive data via the RS232, select "Reception mode" in the field "RS 232 Communication".

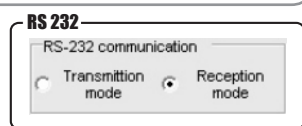

### III2c - Slave address :

Class 300, DIS

To modify the transmitter slave address (Modbus network), use the arrows on the right side of the zone "Slave number (Modbus)" or directly enter the number.

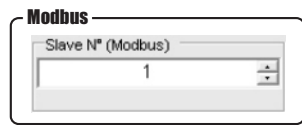

### III2d - Keyboard locking :

Class 300, 200 \* Except CPE 300

For safety reasons, you can lock the keypad. When locked, the keypad will not respond (same as on mobile phone).  
 To lock the keypad, select "ON" in "Keyboard locking".  
 To unlock the keypad, select "OFF".



### III2e - Backlight :

Class 300, 200 \* Except CPE 300

The back lighting makes the reading easier when the ambient light is too faint. To activate the back lighting, select "ON" in "Backlight". To deactivate the back lighting, select "OFF".





### III2f - Display contrast setting :

Class 300 \* Except CPE 300  
Class 200

To modify the contrast of the display, use the arrows on the right side of the zone "Contrast setting" or directly enter the value (from 0 to 10).

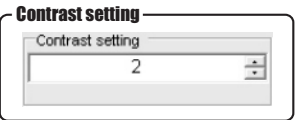

### III 3 - Configuration of the channels and units of measurement :

#### III3a - Input configuration

DIS



ATT 300 and ATE 300 displays have both 3 analogue inputs (0-10V or 4-20mA), 1 RS 232 digital input, and one RS 485 digital input (MODBUS system). 2 different inputs are available: **analogue and digital inputs**. The tab "General Info" gives access to the selection of input required.

#### 2 configuration types available

- 0-10V analogue input
- RS 485 digital input
- RS 232 digital input

#### 1- Display of a measuring system values, via

##### Analogue inputs and RS 232

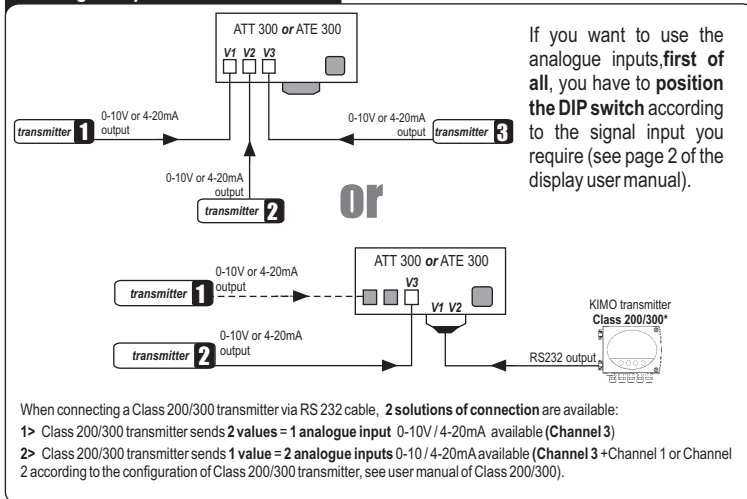

#### 2- Display of a measuring system values via

##### Digital input

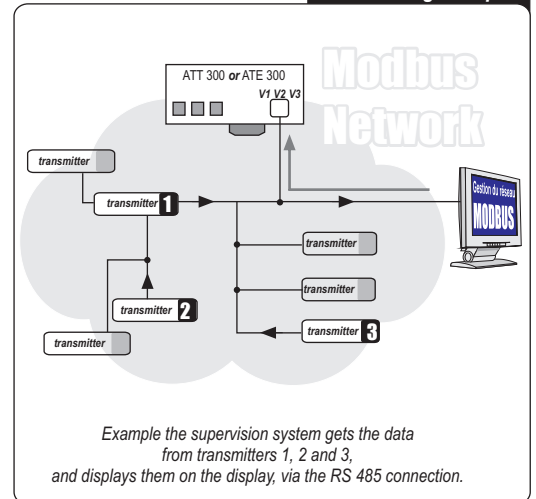

#### III3b - Units and channels :

Class 300  
Class 200

The tab "Channels" gives access to the measurement channels of the transmitter. **Transmitters from class 300** have 4 measurement channels. You can activate 1, 2, 3 or 4 channels and select a measurement unit for each channel.

**Transmitters from class 200** have 2 measurement channels. You can activate 1 or 2 channels and select a measurement unit for each channel.

**A channel is activated** when a measurement unit is displayed.. **A channel is deactivated** when the display shows "None". To modify a measurement unit or deactivate a channel, click on the arrow on the right side of the zone corresponding to the involved channel : the list of the pre-set units, including "None", is displayed.

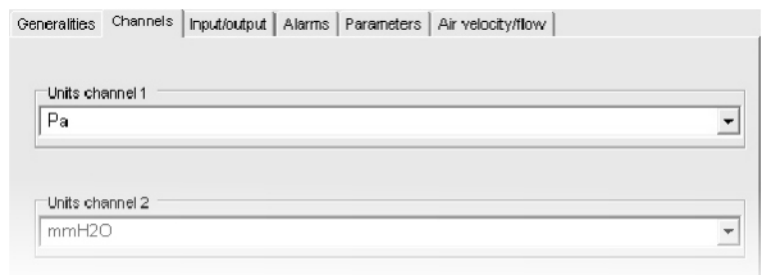



### Transmitters

### Available Units

<b>CP300</b> .....	Pa - mmH <sub>2</sub> O - inWg - mbar - °C - °F - m/s - fpm - m <sup>3</sup> /h - L/s - cfm - m <sup>3</sup> /s
<b>CP 201 and CP 202</b> .....	Pa - mmH <sub>2</sub> O - inWg - mbar - mmHG - m/s - fpm - m <sup>3</sup> /h - L/s - cfm - m <sup>3</sup> /s
<b>CP 203 and CP 204</b> .....	mbar - inWg - KPa - PSI - mmHG - m/s - fpm - m <sup>3</sup> /h - L/s - cfm - m <sup>3</sup> /s
<b>TH300 and TH200</b> .....	°C - °F - %HR - g/Kg (Absolute Humidity p) - °C (Dew Point Td) - °F (Dew Point Td) - °C (Wet Temperature Tw) - °F (Wet temperature Tw) - KJ/KG (enthalpy i)
<b>TT300</b> .....	°C - °F
<b>CTV 200-210-310</b> .....	m/s - fpm - °C - °F - m <sup>3</sup> /h - L/s - cfm - m <sup>3</sup> /s
<b>ATT300 and ATE300</b> .....	m/s - fpm - m <sup>3</sup> /h - L/s - cfm - m <sup>3</sup> /s - °C - °F - %HR - PSI - Pa - mmH <sub>2</sub> O - inWg - KPa - mmHG - mbar - g/Kg - °C (Dew Point Td) - °F (Dew Point Td) - °C (Wet Temperature Tw) - °F (Wet Temperature Tw) - KJ/Kg



For CP300 and CP200 series, the transmitter must have the **SQR option** in order to activate the velocity and flow units.

This tab also allows to display measurements : by clicking on "Measure" button, a window opens and indicates value and units for each activated channel.

To close the window, click on "Close" button.

Units

1	39,6 Pa
2	22,1 °C

Channel number

Value



### III3c - Management of configurable units : DIS

The ATE300 and ATT300 displays can have a specific unit : **the configurable unit**. It allows to add a new unit to the existing list of pre-set units.

- Select one channel.
- Select “Configurable Unit”. On the right of the channel, the outlines of the 4 digits appear (figure 1). Click on the segments required to activate it.
- Repeat the process till the unit you need is created (see figure 2).

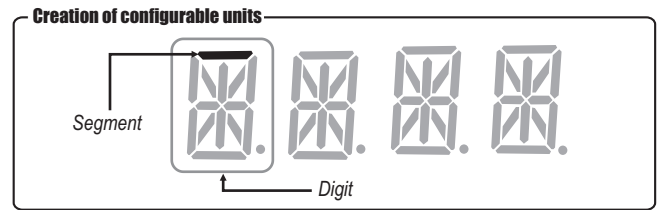
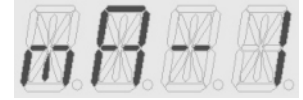

Figure 1



Figure 2



### III 4 - Management of analogue outputs :

#### III4a - Setting the analogue outputs : 300 200 DIS

This function allows you to modify the measuring range of your transmitter and to link the limits of this new measuring range to the analogue output (0-10V or 4-20mA).

**You must enter the measuring range required.**



**The values depend on the selected measurement unit and not on the transmitter measuring range.**

*Example : the minimum and maximum limits on a pressure transmitter type CP303 (0 to ±1000 Pa) with reading in mmH<sub>2</sub>O must be configurated on a measuring range from 0 to ±102 mmH<sub>2</sub>O. See conversion chart for measurements units (page 7).*

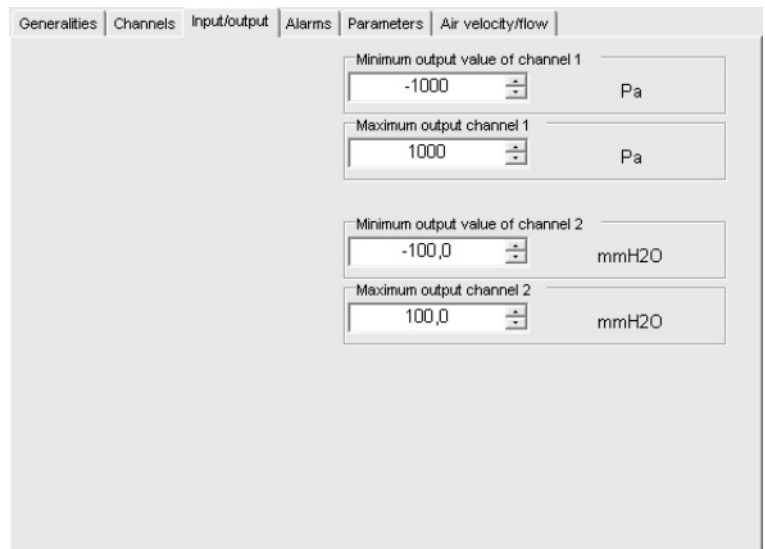

To modify the minimum and maximum value of the transmitter analogue output(s), please use the arrows located on the right side of zone “Minimum output value...” and zone “Maximum output channel...”, or directly enter the new values.



**Our recommendation : delta between minimum and maximum > 5% of the measuring range.**



**In case the measurement unit was modified while configurating the analogue outputs (see page 5), then the outputs will have to be configurated again with the new measurement unit.**

#### III4b - Activating / deactivating the analogue inputs : DIS

You may activate or deactivate the analogue inputs of the ATE300 and ATT300 displays in order to show 1, 2 or 3 channels.

To activate an analogue input, choose the channel you need and select “ON” in the zone shown beside.

To deactivate the analogue input, select “OFF”.

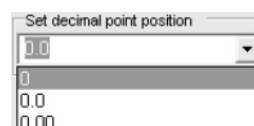
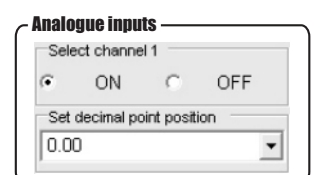

You may also modify the position of the decimal point : click on the right side of the zone “Set decimal point position” to display the list of the pre-set options (see beside).



### III4c - Conversion chart :

#### Pressure

	Pa	mmH2O	inWg	mbar	mmHg
CP 301	0 à ±100	0 à ±10,2	0 à ±0,401	0 à ±1,00	-
CP 302	0 à ±500	0 à ±51,0	0 à ±2,005	0 à ±5,00	-
CP 303	0 à ±1000	0 à ±102,0	0 à ±4,015	0 à ±10,00	-
CP 304	0 à ±10000	0 à ±1020,0	0 à ±40,15	0 à ±100,00	0 à ±75,00

	Pa	mmH2O	inWg	mbar	mmHg	KPa	PSI
CP201	0 à ±1000	0 à ±102,0	0 à ±4,015	0 à ±10,00	0 à ±7,50	-	-
CP202	0 à ±10000	0 à ±1020,0	0 à ±40,15	0 à ±100,00	0 à ±75,00	-	-
CP 203	-	-	0 à ±200,0	0 à ±500	0 à ±375	0 à ±50,0	0 à ±7,50
CP 204	-	-	0 à ±800,0	0 à ±2000	0 à ±1500	0 à ±200,0	0 à ±30,00

#### Temperature

	°C	°F
TH200 / 300 - St. steel probe	-40,0 à +180,0	-40,0 à +356,0
TH 200 / 300 - PC probe	-20,0 à +80,0	-4,0 à +176,0
TT 300 - St. steel probe	-40,0 à +180,0	-40,0 à +356,0
TT 300 - PC probe	-20,0 à +80,0	-4,0 à +176,0
CTV 200 / 210 / 310	0,0 à +50,0	+32,0 à +122,0

#### Velocity

	m/s	fpm
CTV200	0,0 à 20,0	0 à 3937
CTV210	0,0 à 30,0	0 à 5905
CTV310	0,0 à 30,0	0 à 5905

### III 5 - Setting of alarms / relays :

The tab "Alarms" gives access to all the information relative to the configuration of the alarms/relays :

- Activate / deactivate the buzzer.
- Security level of alarms.
- Tags for alarms / relays and LED color control.
- Select the channel for visual alarms and relays.
- Explanations of alarms mode available.
- Set the set points and time-delay.

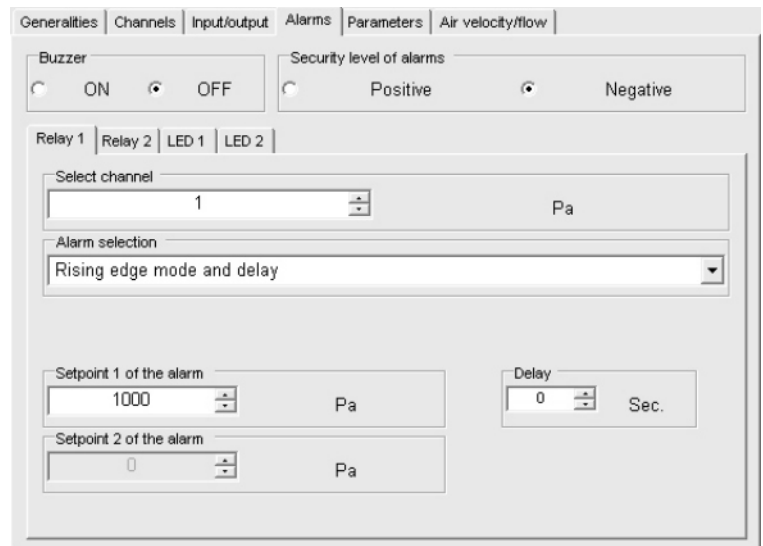

### III5a - Activating / deactivating the buzzer :



In case of alarm, a beep is activated.  
For more information on the setting of the set points, see page 10.  
To activate the beep, select "ON" in the "Buzzer" zone.  
To deactivate the beep, select "OFF".



### III5b - Security level of alarms :



The relay outputs are pre-set on **negative security level** : the relay is **excited** in case of alarm . Via the software, you can configure the relays on **positive security level** : then the relay is **deexcited** in case of alarm or power cut.

To select the negative alarm condition, click on "Negative" in "Security level of alarms" zone.  
To select the positive alarm condition, click on "Positive".



**III5c - Tags for alarms/relays and LED color control :** Class 300  
Class 200

**Visual and audible alarms :**

Transmitters from class 200 and 300 (except the displays) have 2 visual /audible alarms located on the front of the transmitter. In case of alarm, they give an immediate visual and audible signal.

**LED color control for alarms**

- Green** The alarm is activated, but there is no alarm condition.
- Red** The alarm is activated and the transmitter is in alarm condition.
- None** The alarm is **not** activated.

**NOTE** When the LED turns red, it means that not only the setpoints but also the time-delay and the edge were taken into account. See page 10 for more information.

**Beep**

**Once the alarm is activated, the beep remains on as long as the condition is respected.**

**NOTE** The buzzer must be activated to get the beep. See page 7.

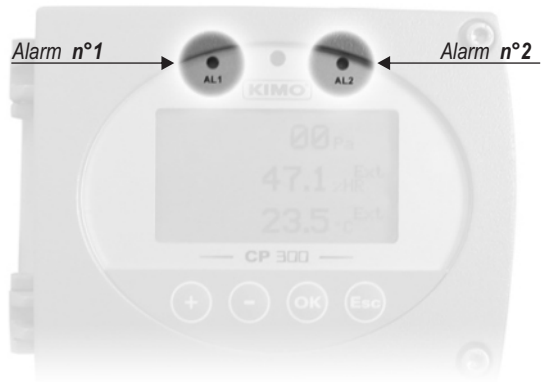

**Relays :**

Transmitters from class 200 and 300 (except the displays) have 2 visible relays on their electronic card . Each one of these 2 relays have a LED for an immediate visualization in case of test.

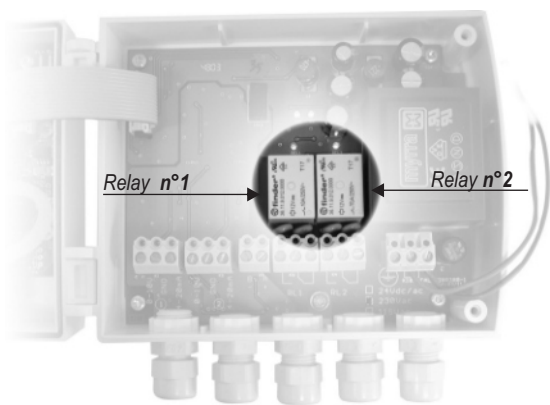

**LED color control for relays**

- Red** The relay is activated
- None** The relay is not activated or was not configured

**NOTE** When the light turns red, it means that not only the setting of the set points but also the setting of the time-delay, of the edge and most particularly of the level of alarm security were taken into account. Set points, time-delay and edge : see page 10. Secure the alarms : see page 7

**III5d - Selecting the channel for visual alarms and relays :** Class 300  
Class 200

Transmitters from class 200 and 300 (except displays) have 4 alarms :

- 2 visual and audible alarms (**LED 1 and LED 2**)
- 2 relay alarms (**Relay 1 and Relay 2**).

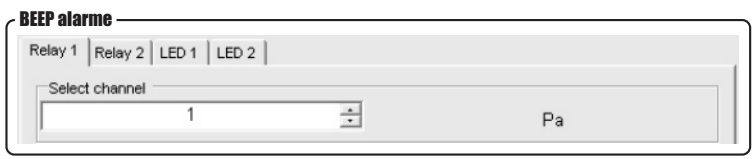

Therefore, the transmitter can be configured according to **4 different types of security instructions**. To select the channel to which you want to send the instruction, use the arrows located on the right side of the zone "Select channel", or directly enter the value (from 1 to 4).



### III<sub>5e</sub> - Explanations of available alarm modes :

Class 300  
Class 200

#### Description :

##### Set point

The set point is a limit that, once exceeded, will activate an alarm or a relay (for more information on negative security, see page 7).

##### Time-delay

Once the set point is exceeded, the time-delay will postpone the activation of the alarm/relays. Once the delay (secondes) is over, and in case the set point is still exceeded, the alarm/relay will be activated (in negative security).

##### Edge

The edge allows to decide of the alarm action (rising or falling) or the excitation of the relay.

- **Rising edge** : the alarm is activated when the measurement **goes over** the set point
- **Falling edge** : the alarm is activated when the measurement **goes under** the set point.

#### Available configurations :

#### Configuration N°1 : 2 set points and time-delay

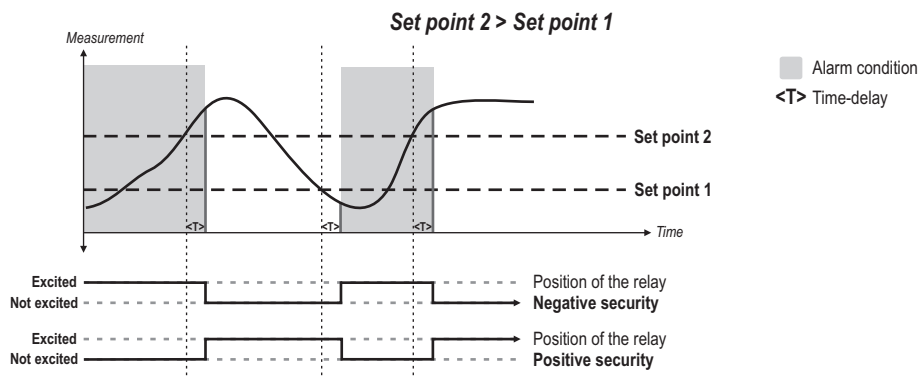
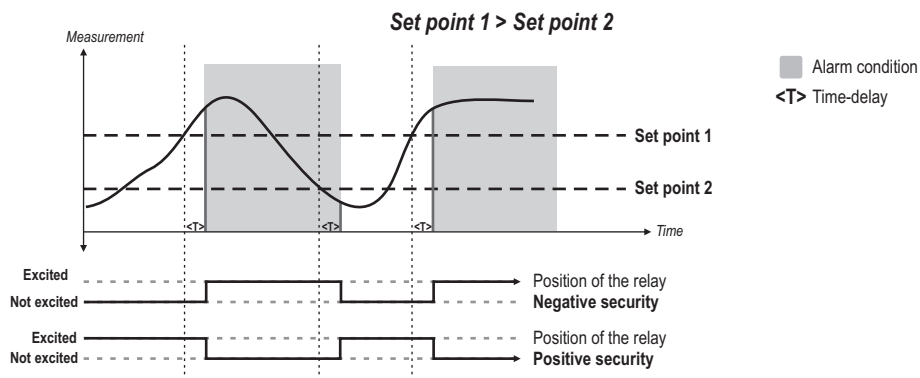

#### Configuration N°2 : 1 set point, time-delay and rising edge

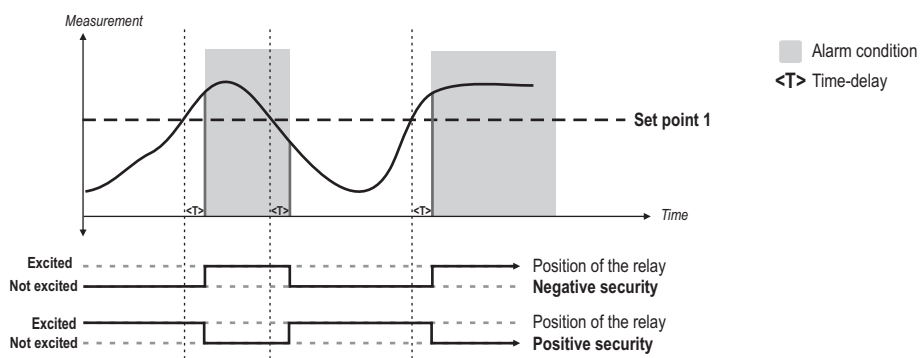

**Configuration N°3 : 1 set point, time-delay and falling edge**

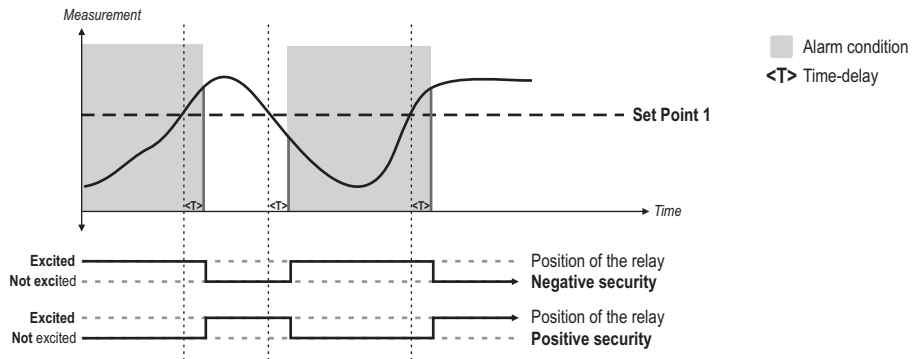

**III5f - Alarm selection :**

Class  
**300**  
Class  
**200**

To select the alarm mode, click on the arrow on the right side of the zone "Alarm selection" to display the list of the pre-set functions :

- No alarm.
- Control mode (Set point 1, Set point 2 and delay) (N° 1 see page 9).
- Rising edge mode and delay (N° 2 see page 9).
- Falling edge mode and delay (N° 3 see figure above).

**Alarm selection**

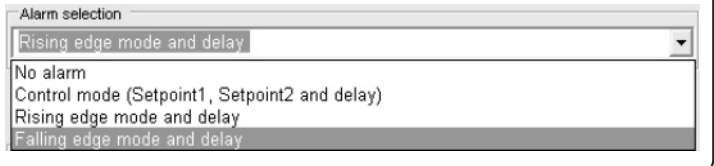

**It is possible to select 1 different mode of alarm for each relay (Relay 1 and 2) and for each visual alarm (LED 1 and 2).**

**III5g - Setting the set points and time-delay :**

Class  
**300**  
Class  
**200**

**Set points :**

To set the alarms set points, use the arrows on the right side of the zone "Setpoint 1 of the alarm" and "Setpoint 2 of the alarm", or directly enter the value.



**The values to enter depend on the measurement unit selected and not on the measuring range of the transmitter.**

**Set points**



*Ex. For a pressure transmitter type CP303 (0 to ±1000 Pa) with reading in mmH<sub>2</sub>O, the set points must be configured on a measuring range between 0 and ±102 mmH<sub>2</sub>O. See conversion chart page 7.*



• If, after setting the set points, the measurement unit has changed (see page 5), then you must re-configure the set points according to the new measurement unit.

**Delay :**

To adjust the time-delay, use the arrows on the right side of the zone "Delay", ou directly enter the value (from 0 to 60 sec.).

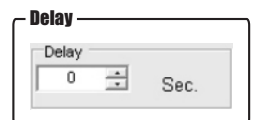



### III 6 - Configuration of pressure measurement:

#### III6a - Pressure integration coefficient :



The integration factor allows to smooth the measurement to avoid inadvertent fluctuations.

**New value displayed =**

$$[(10 - \text{factor}) \times \text{New value}] + (\text{Factor} \times \text{Old value}) / 10$$

This formula can be applied when the fluctuation is lower than +/- (Factor x 10 Pa)

**Example : CP303 (0-1000 Pa) - Previous measurement : 120 Pa - New measurement : 125 Pa**

The pressure source being stable, the user chooses a low integration. Integration : 1, maximum fluctuation authorised +/-10 Pa. The fluctuation is inferior to 10 Pa, therefore we can use the formula to calculate the integration.

Next measurement displayed :  $(9 * 125) + (1 * 120) / 10 = 124.5$  that is 124 Pa. If the new value had been 131 Pa, the next value showed would have been 100% of the new value, that is to say 131 Pa.

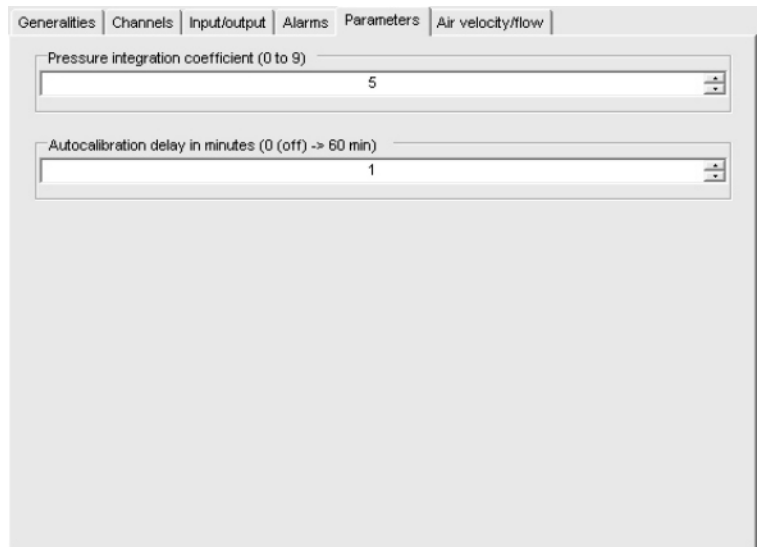

To set the integration value, click on tab "Parameters" and use the arrows located on the right side of the zone "Pressure integration coefficient", or directly enter the value (from 0 to 9).

**Factor 0 :** no integration.

**Factor 9 :** maximum integration, reading more stable.

#### III6b - Time-delay between 2 self-calibration :



To set the time-delay between 2 self-calibration, click on tab "Settings" and use the arrows located on the right side of the zone "Time-delay between 2 self-calibration", or directly enter the value (from 0 to 60 min).

**Time-delay 0 :** no self-calibration.

**Time-delay 60 :** maximum delay between 2 self-calibration (60 min).

### III 7 - Humidity measurement configuration:

#### III7a - Setting of offset in humidity and temperature:



In order to avoid any drift of the measurement, you can add an offset to the value displayed by the TH 200 / 300 via our reference portable instrument EHK 500 or via the LCC 300 software.



Function only available on humidity transmitters TH 200 / 300

The EHK 500 is a reference portable instrument (optional) which enables you to adjust in humidity and temperature, via the RS232 connection cable. This new system is time-saving: no need to return the transmitter to our factory., you can carry out on-site adjusting.

**Your transmitter is always available.** See technical datasheet and user manual of EHK 500.

#### III7b - Resetting of offset:



#### For transmitters with version <= 1.6

If your transmitter is adjusted in humidity and temperature with the EHK 500, you can reset the offset whenever you want.

Click on the tab "Settings" then on the box "Initialzation" of the window "Offsets of humidity and temperature".

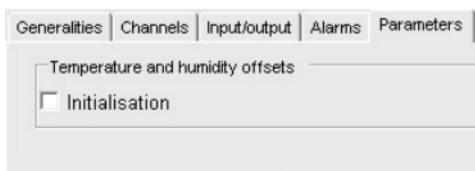

#### For transmitters with version => 1.6



In the tab "Settings", you can enter the offset in humidity and temperature.

**Nota :** the offset in temperature can be entered either in °C or in °F (automatic conversion).

#### Offset ranges

%RH	-50,0 to +50,0
°C	-50,0 to +50,0
°F	-90,0 to +90,0



### III 8 - Configuration of air velocity measurement :

The tab "Air velocity / flow" gives access to all the information about air velocity and air flow measurement :

- Temperature compensation mode.
- Select air velocity probe.
- Select air velocity correction coefficient.
- Select duct type or flow coefficient.

#### III 8a - Type of temperature compensation :



It is possible to **modify the temperature compensation value**. Indeed, the air velocity and the airflow measured with a Pitot tube and/or Debimo (or with any other differential probe) depends on the working temperature.

Therefore, it is necessary to enter **the working temperature** in order to get more coherent results.

This value can be either entered manually or with the help of a thermocouple K probe for an automatic temperature compensation.

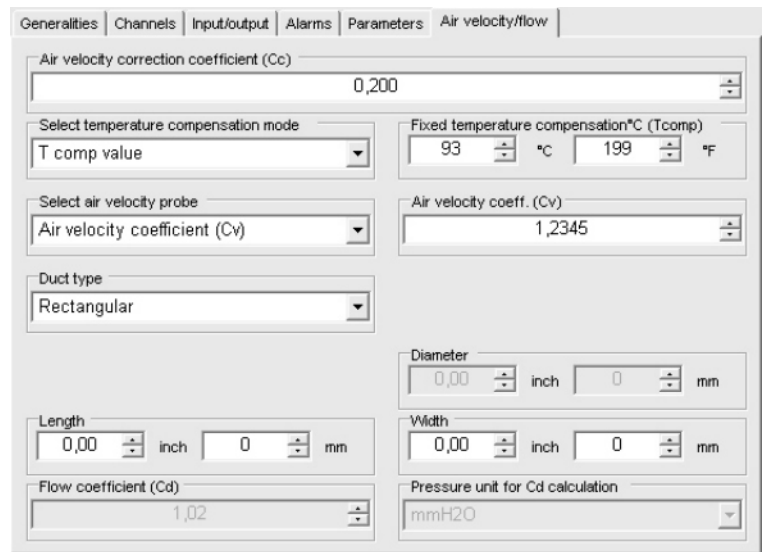

#### Automatic compensation :

For automatic setting of the temperature compensation, select "External probe temperature" in zone "Select temperature compensation mode".

#### Automatic compensation



Once the configuration process of the temperature compensation is over, **make sure the connection of the thermocouple K probe** is OK.

#### Manual compensation :

For manual setting of the temperature compensation, select "Temperature compensation Value" in the zone "Select temperature compensation mode".

The zone "Fixed temperature compensation °C" is activated. Then you can enter the working temperature in °C or °F. Use the arrows located on the right side of the zone or directly enter the value.

#### Manual compensation

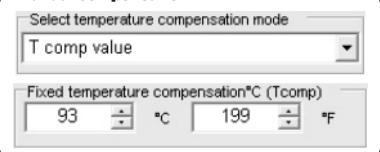

If you compensate the temperature in Celsius degrees, the software will automatically make the conversion into Fahrenheit and vice versa.





### III8b - Selecting the air velocity coefficient :



Since pressure and differential probe are used to calculate the air velocity, you must **enter the differential probe coefficient value**. The coefficient of the Pitot tube and of the Debimo are both integrated in the transmitter.



This function is only available on pressure transmitters type **CP 200 / 300 + optional SQR**

#### Automatic input of coefficient :

For automatic setting of the air velocity coefficient, select “Debimo” or “Pitot” in the zone “Select air velocity probe” according to the differential probe to be used.

#### Automatic input of coefficient

Select air velocity probe

Air velocity coefficient (Cv)

Pitot

Debimo

Air velocity coefficient (Cv)

#### Manual input of coefficient :

For manual setting of the air velocity coefficient, select “Air velocity coefficient (Cv)” in the zone “Select air velocity probe”.

The zone “Air velocity coeff. (Cv)” is activated. Use the arrows located on the right side of the zone or directly enter the value required.

#### Manual input of coefficient

Select air velocity probe

Air velocity coefficient (Cv)

Air velocity coeff. (Cv)

1,2345

### III8c - Input of air velocity correction coefficient :

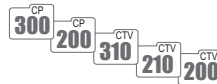

With this correction coefficient, you may adjust the transmitter according to the air velocity data of your installation.



This function is only available on transmitters type **CP 200 / 300 + optional SQR and CTV 200 / 210 / 310**

#### How to calculate the coefficient :

For example, you know that the air velocity in your duct is equal to **17 m/s** and that the transmitter shows **16.6 m/s**. Then the coefficient to be applied is **17 / 16,6** that is to say **1.024**

#### Input of coefficient :

Use the arrows located on the right side of the zone or directly enter the value requested (from 0,200 to 2,000).

#### Air velocity correction coefficient

Air velocity correction coefficient (Cc)

0,200

### III8d - Selecting the duct type and the flow coefficient :



It is possible to work from a type of section (rectangular or circular) or from flow coefficient for airflow measurement.

#### Duct type

Duct type

Rectangular

Rectangular

Circular

Flow coefficient

#### Rectangular duct :



This function is only available on transmitters type **CP 200 / 300 + SQR and CTV 200 / 210 / 310**

For rectangular duct, select “Rectangular” in the zone “Duct type”. The zones “Length” and “Width” are activated. You can then enter the rectangular duct length and width (in inch or mm). Use the arrows on the right side of the zones or directly enter the required value.

#### Rectangular duct

Duct type

Rectangular

Length

3,94 inch 100 mm

Width

1,97 inch 50 mm



If you enter the length and width in “inch”, then the software will automatically make the conversion into “mm” and vice versa.



### Circular duct :

This function is only available on transmitters type **CP 200 / 300 + SQR** and **CTV 200 / 210 / 310**

For circular duct, select “Circular” in the zone “Duct type”.  
The zone “Diameter” is activated. You can then enter the circular duct diameter (in inch and mm). Use the arrows located on the right side of the zones or directly enter the required value.

**NOTE** If you enter the diameter in “inch”, then the software will automatically make the conversion into “mm” and vice versa.

**Circular duct**

Duct type  
Circular

Diameter  
0,39 inch 10 mm

### Flow coefficient :

This coefficient allows to calculate airflow using pressure. It is indicated by the manufacturer who supplies the system equipped with pressure intakes (+ et -). The square root of the measured pressure (Delta P) and the factor will enable you to get the airflow.

$$\text{Airflow} = C_o \times \sqrt{\Delta \text{Pressure}}$$

This function is only available on transmitters type **CP 200 / 300 + SQR**.  
With this calculating process, you will **not be able to read air velocity anymore**. If you activate this calculating process and a velocity channel, then the transmitter will show an **error type 4**.  
**To avoid this situation :**

- Select an airflow unit for channel 1, 2, 3 or 4
- Instead, select the airflow factor, a circular or rectangular duct in the zone “Duct type”

For airflow coefficient, select “Flow coefficient” in the zone “Duct type”.  
The zones “Flow coefficient (Cd)” and “Pressure unit for Cd calculation” are activated.  
You can then enter an airflow factor and a pressure unit. Use the arrows located on the right side of the first zone or directly enter the airflow factor value required (from 0,01 to 999,99).  
Click on the arrow on the right side of the second zone to display the list of the pre-set-units, according to the transmitter used.

**Rectangular duct**

Duct type  
Flow coefficient

Flow coefficient (Cd)  
1,02

Pressure unit for Cd calculation  
mmH2O

CP201 and 202 CP203 and 204	
Pa	-
-	Kpa
inWg	inWg
mbar	mbar
mmHg	mmHg
-	PSI
mmH <sub>2</sub> O	-

CP301/302/303	CP304
Pa	Pa
mmH <sub>2</sub> O	mmH <sub>2</sub> O
inWg	inWg
mbar	mbar
-	mmHg



### III 9 - Purge Mode:

The purge mode enables to freeze the measurement when being displayed, enables to lock the analogue outputs, and to activate the relay 1, in order to actuate a de-dust system of an air movement conditions system and to activate the relay 2 in order to isolate the transmitter.

#### III 9a - Activation / deactivation of purge mode :



To activate the purge mode, select "ON" in "Fonction Purge" zone. To deactivate the purge mode, select "OFF".

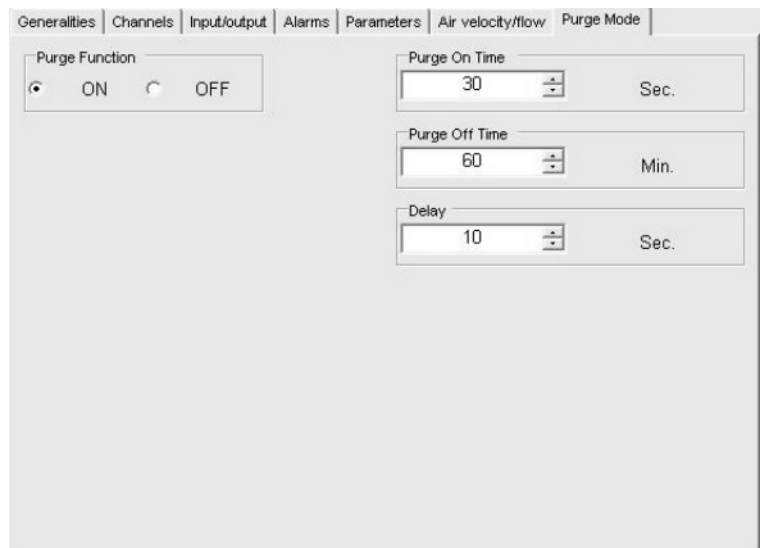

#### III 9b - Working duration of purge mode :



For manual setting of working duration of purge mode, use the arrows located on the right side of the "Purge on time" zone or enter the value directly (from 1 to 60 sec).



#### III 9c - Frequency :



For manual setting of frequency, use the arrows located on the right side of the "Purge off time" zone or enter the value directly (from 1 to 9999 min).



#### III 9d - Time-delay :



Once the purge is finished, time-delay is a time period before the transmitter returns to measurement mode and before the analogue outputs are reactivated.



For manual setting of time-delay, use the arrows located on the right side of the "Delay" zone or enter the value directly (from 0 to 60 sec).



### III 9 - Error codes:

Code	Problem	Solutions
01	Configuration conflict between the alarms setting and the displayed (activated) channels.	<ul style="list-style-type: none"> <li>Check the condition of the 4 alarms and of the 4 channels.</li> <li>Ex. : If an alarm is configured on an inactive channel (1,2,3 or 4), the error mode is activated. You must deactivate the channel on which you want to set an alarm condition.</li> <li><b>Activating a channel</b> : see page 5</li> <li><b>Configuration of alarms and relays</b> : see page 8</li> </ul>
02	No activated channel.	<ul style="list-style-type: none"> <li>You must at least activate 1 channel to avoid this error code.</li> <li><b>Activating a channel</b> : see page 5</li> </ul>
03	Humidity probe (TH 200 / 300) or SPI (CP 200 / 300 / CPE 300) not connected Temperature probe (TT300) not connected	<ul style="list-style-type: none"> <li>Connect the probe / SPI (see SPI user manual)</li> </ul>
04	Only for CP 200 / 300. One channel is configured for velocity (see page 5) and the function to calculate airflow (page 14) is on position 02 (airflow factor). This combination is not allowed.	<ul style="list-style-type: none"> <li>Select an airflow unit for channel 1, 2, 3 or 4 (see configuration of the channels, page 5)</li> <li>Instead of the airflow factor, select a circular or rectangular duct. (see page 13)</li> </ul>

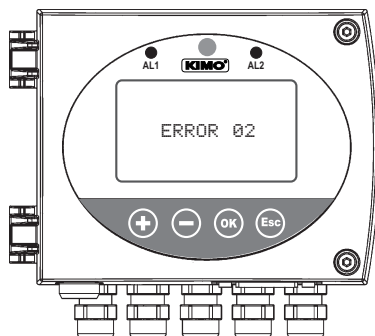
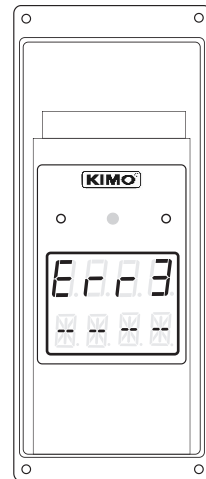

## IV - Transferring a configuration to the transmitter

There is a writing bar above the configuration tabs.  
When the configuration of the connected transmitter is displayed or when you open a pre-set configuration, the writing bar is shaded.

When you modify a parameter, the writing bar turns red. It means that the configuration displayed on the software screen is not the same anymore than the one of the transmitter. Once all the required modifications were made (generalities, channels, inputs/outputs, alarms, parameters, air velocity/flow), click on the writing bar to transfer the new data to the transmitter.

### Writing the configuration

#### Writing bar when opening a configuration

**Write configuration**

**Write configuration**

Generalities	Channels	Input/output	Alarms	Parameters	Air velocity/flow
Designation	Serial N°	Software version			
CP304	03.12.0012	1.0			

**Writing bar after modification and before transfer to the transmitter.**

**Write configuration**



If you transfer a configuration that does not correspond to the type of the connected transmitter (class and/or parameter) the message beside will appear.

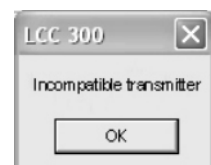



## V - Saving a configuration

### V1-Principle:

Using the function "Save configuration", you can record different configurations in a database, and also the modifications.

### V2-Saving a configuration :

Please follow carefully the different steps as below :

- Using the "Read configuration" function, read the parameters of the transmitter.
- Make some modifications if required
- Write the new configuration after having modified
- In the menu "Commands" click on "Save configuration".

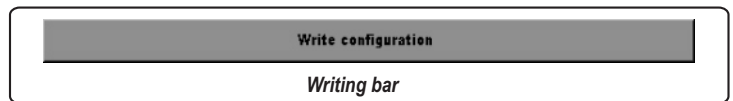

 The first step is to transfer the new configuration to the transmitter (by clicking on the writing bar). Then, you can save it in the database.

The window shown beside appears. On the bottom of the window, the field enables you to name each saved configuration. If you do not fill it in, and by default, the date and time of save will be displayed.

**Note :** the names of the configuration re preceded by the name of the transmitter which is connected.

**Save configuration**

*Data field :*  
enables to give a name any configuration saved.

Click on "Cancel" to cancel the save or click on "OK" to continue. By clicking on "OK", the window beside is displayed. Click on "OK" to return to the main menu.

**Save correctly done**

 If you save a configuration with a name that already exists **for the same transmitter**, the message shown beside will be displayed. Click on "OK" to come back to the initial save window. Enter a new name, and then click on "OK".



## VI - Opening a configuration

### Function : OPENING A CONFIGURATION

When launching the LCC-300 software, two buttons are displayed :

- **Read configuration**
- **Open configuration from database**



### VI1- Principle:

Using the function "Open configuration from database", you may access to the database of all the different configurations saved. Then, it is possible to match one configuration with one (or several) transmitter(s). You do not need to make the configuration each time.

- Open a configuration.
- Transfer a configuration to one or several transmitter(s)
- Delete a configuration.



If you click on "Open a configuration" without having previously saved any configuration, the message shown beside will appear. (See chapter IV "Save a configuration").

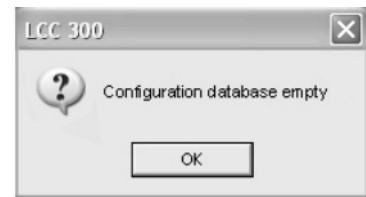

### VI2- Opening a configuration:

To open a configuration, click on "Open configuration from database" or go into "Commands", and then click on "Open configuration from database" (see page 18). The window shown beside will be displayed.

#### To choose a configuration :

- First select the type of transmitter that you want to configure (first box). The configurations saved are displayed in the second box.
- Then select the configuration required.

*ex : to choose a configuration for a CP300 pressure transmitter, select CP 200-300 in the first box. The list of the configurations saved for CP 300 is then displayed in the second box.*

### Open a configuration

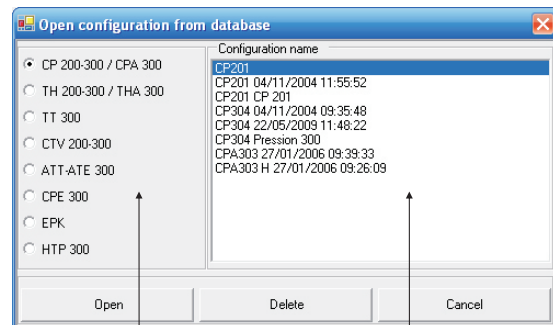

First box  
TRANSMITTER TYPES

Second box  
CONFIGURATIONS



If you choose a transmitter type for which no configuration was done, the message "No configuration" will be displayed in the second box.





To open a configuration, click on the name of the configuration required (as explained page 17). The name chosen is then displayed in a coloured zone. Click on "Open". The window shown beside asks you to confirm the opening. Then click on "Yes".  
 To transfer the configuration to a transmitter which is connected, click on the writing bar or go into "Commands" and click on "Write configuration" (see page 18).

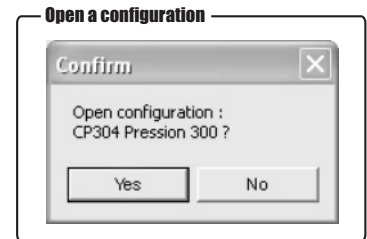

### VI 3 - Transferring a configuration :

To transfer the configuration parameters to a transmitter, please open the configuration required (see page 15). Click on the writing bar or go into menu "Commands", then "Write configuration" (see page 18).

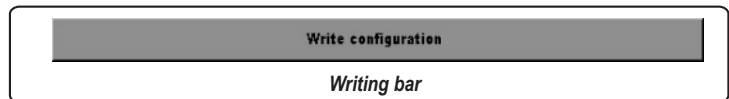

### VI 4 - Deleting a configuration :

To cancel a configuration, click on the name of the configuration required (as explained page 17). The name is then displayed on a blue background. Click on "Cancel". The window shown beside appears to ask you to confirm. Then click on "Yes".

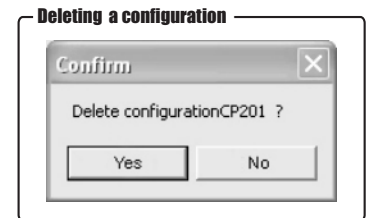

## VII - Main menu

### "Commands" Menu

- "Read configuration"* • see page 3
- "Save configuration"* • see page 16
- "Open configuration from database"* • see page 17
- "Write configuration"* • see page 15
- "Quit"* • to quit the LCC 300 software

### "Parameters" Menu

- "Select COM port"* to modify the communication port used.
- "Select language"* to choose the language.
- "Tips"* to allow the display of helping windows.
- "Options"* is exclusively used by KIMO's Aftersales Service.



### "Help" Menu

*"Info"* to access to the details of information relative to the software (name and version).





**[www.kimo.fr](http://www.kimo.fr)**

**EXPORT DEPARTMENT**

Boulevard de Beaubourg - Emerainville - BP 48  
77312 MARNE LA VALLEE CEDEX 2

**Tel : + 33.1.60.06.69.25 - Fax : + 33.1.60.06.69.29**

